

Phase Shifter, 6-Bit Digital
7.0 — 12.0 GHz

MAPCGM0005
903212 —
Preliminary Information

Features

- ◆ 7.0 to 12.0 GHz Operation
- ◆ 6 Bit Phase Shifter
- ◆ 360° Coverage, LSB = 5.6°
- ◆ TTL Control Inputs
- ◆ 5mm, 28 Lead, FQFP-N Package
- ◆ GaAS MSAG™ Process

Primary Applications

- ◆ Satellite Communication
- ◆ Military and Weather Radar

Description

The MAPCGM0005 is a 6-bit Phase Shifter with Parallel TTL Input Control and is packaged in a micro lead package (MLP). This product is fully matched to 50 ohms on both the input and output. This part has 360° of phase coverage in 5.6° increments.

Fabricated using M/A-COM's repeatable, high performance and highly reliable GaAs Multifunction Self-Aligned Gate (MSAG™) Process, each device is 100% RF tested on wafer to ensure performance compliance.

M/A-COM's MSAG™ process features robust silicon-like manufacturing processes, planar processing of ion implanted transistors, multiple implant capability enabling power, low-noise, switch and digital FETs on a single chip, and polyimide scratch protection for ease of use with automated manufacturing processes. The use of refractory metals and the absence of platinum in the gate metal formulation prevents hydrogen poisoning when employed in hermetic packaging.

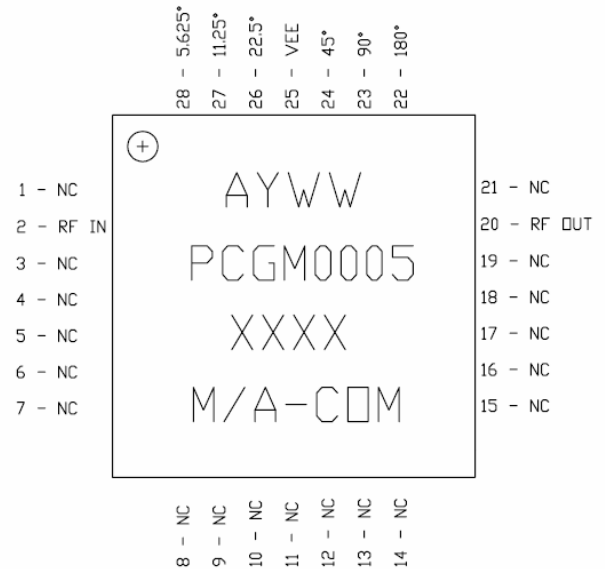

Pin Number	Designation
2	RF IN
20	RF OUT
22	180°
23	90°
24	45°
25	V _{EE}
26	22.5°
27	11.25°
28	5.6°
1,3-19,21	No connection

Maximum Operating Conditions ¹

Parameter	Symbol	Absolute Maximum	Units
Input Power	P _{IN}	27	dBm
Source Supply Voltage	V _{EE}	-6	V
Junction Temperature	T _J	180	°C
Storage Temperature	T _{STG}	-55 to +150	°C

1. Operation outside of these ranges may reduce product reliability. Operation at other than the typical values may

M/A-COM Inc. and its affiliates reserve the right to make changes to the product(s) or information contained herein without notice. M/A-COM makes no warranty, representation or guarantee regarding the suitability of its products for any particular purpose, nor does M/A-COM assume any liability whatsoever arising out of the use or application of any product(s) or information.

- **North America** Tel: 800.366.2266 / Fax: 978.366.2266
- **Europe** Tel: 44.1908.574.200 / Fax: 44.1908.574.300
- **Asia/Pacific** Tel: 81.44.844.8296 / Fax: 81.44.844.8298

Visit www.macom.com for additional data sheets and product information.

Phase Shifter, 6-Bit Digital
7.0 — 12.0 GHz

MAPCGM0005
903212 —
Preliminary Information

Recommended Operating Conditions

Characteristic	Symbol	Min	Typ	Max	Unit
Digital Supply Voltage	VEE	-5.2	-5.0	-4.8	V
Control Voltage	A1 thru A6				
Logic High		3	5	5	V
Logic Low		0	0	0.8	V
Junction Temperature	T _J			150	°C

Electrical Characteristics: T_B = 25°C, Z₀ = 50Ω, V_{EE} = -5V

Parameter	Symbol	Typical	Units
Bandwidth	f	7.0-12.0	GHz
Insertion Loss	IL	11	dB
Input VSWR (At Reference)	VSWR	2.5:1	
Output VSWR (At Reference)	VSWR	1.8:1	
RMS Phase Error	RMS	6	°
RMS Phase Error — Calibrated	RMS	3	°
Phase Range	ΔΦ	360	°
Gain Variation over all Phase Shifter settings	ΔG	< 3	dB
Digital Supply Current	I _{EE}	< 7	mA
Input Third Order Intercept	ITOI	34	dBm
Input 1-dB Compression Point	P _{1dB}	23	dBm

Operating Instructions

This device is static sensitive. Please handle with care. To operate the device, follow these steps.

1. Apply V_{EE} = -5 V.
2. Apply Logic Voltages to control circuit as listed in Recommended Operating Conditions Table.
3. Power Down. Set V_{EE} = 0.



Phase Shifter, 6-Bit Digital
7.0 — 12.0 GHz

MAPCGM0005
903212 —
Preliminary Information

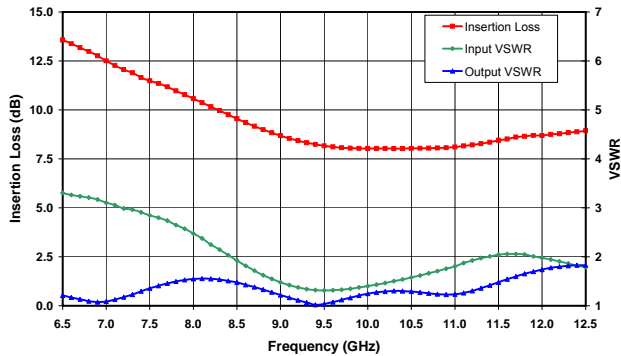

Figure 1. Reference State Insertion Loss, Input and Output VSWR vs. Frequency

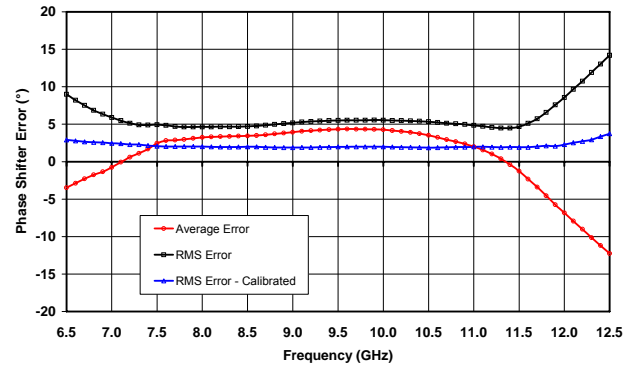

Figure 2. Phase Shifter Figures of Merit: Average Error vs. Reference State, RMS Error and Calibrated RMS Error Over All States

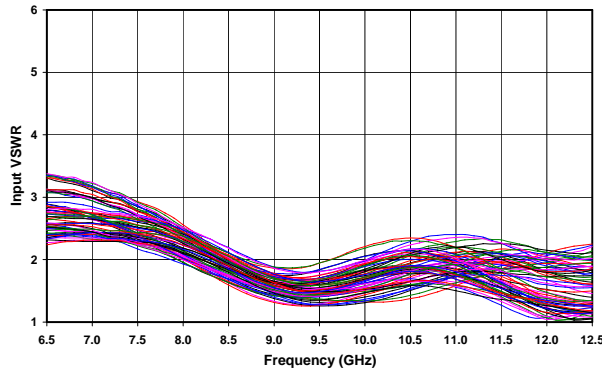

Figure 3. Relative Phase Shift vs. Phase Shifter State

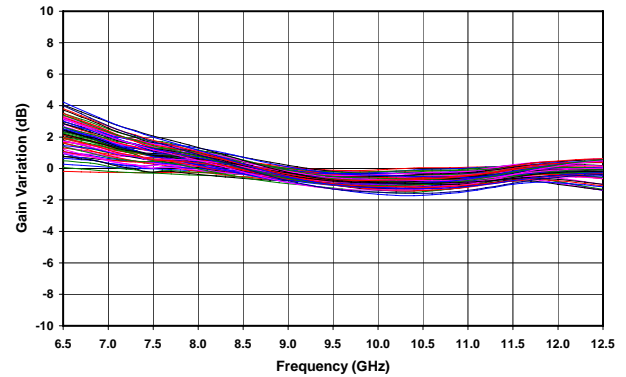

Figure 4. Relative Gain Change vs. Phase Shifter State

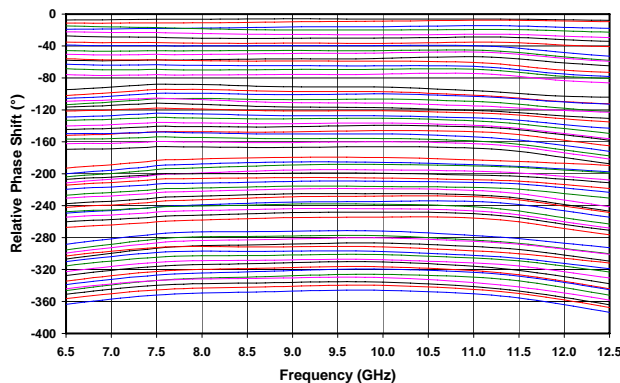

Figure 5. Input VSWR vs. Phase Shifter State

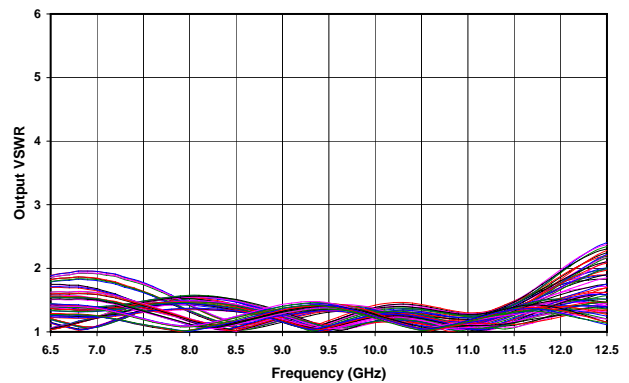

Figure 6. Output VSWR vs. Phase Shifter State

